

Non-contact Line-Laser Probe for Coordinate Measuring Machines Surface Measure

Catalog No. E16000(4)



Highly accurate, high speed, and highly efficient
measurements

Mitutoyo

Highly accurate, high speed, and highly efficient measurements

The SurfaceMeasure probe quickly captures stable shape data on workpieces without being affected by their reflectance.



NEW-STYLE
Coordinate Measuring Machines



Mitutoyo



With a conventional laser probe, laser intensity and camera sensitivity must be adjusted according to the environment and the workpiece material. In contrast, the **SurfaceMeasure Series**, which automatically adjusts these factors, enables simpler and more comfortable laser scanning.

Introducing the new non-contact line-laser probe

The SurfaceMeasure makes it possible to use coordinate measuring machines, until now used primarily as inspection systems, as production systems that can be used throughout the entire process, from development and prototyping to production.

In the development phase

Optimized design utilizing measurement point cloud data significantly improves the efficiency of the development process, even when no master model or CAD data is available for a product.



In the prototyping phase

Shortens the entire process from prototyping to mass production because simulations can be used to compare prototypes with CAD data, check for parts interference and set clearances, and optimize machining settings.



In the production phase

Allows the obtained data to be used for correcting dies, for example, by controlling the variability in mass-produced products, and feeding analysis data back to the preceding process step.

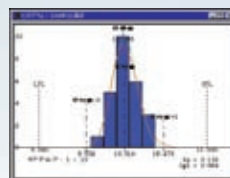
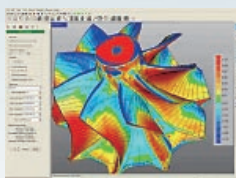

Specifications of the SurfaceMeasure Series

Mitutoyo offers an optimal choice of non-contact probes to satisfy practically any desired combination of accuracy, measuring speed and measuring range.

SurfaceMeasure Lineup

The four probes that make up the SurfaceMeasure lineup operate on any Mitutoyo CNC CMM such as the CRYSTA, STRATO and FALCIO series machines.

Specification

Item\Model		SurfaceMeasure 606	SurfaceMeasure 610	SurfaceMeasure 1010	SurfaceMeasure 606T
Laser irradiation method		Line Laser (single)			Line Laser (cross)
Max. scan width		60mm	60mm	100mm	3×65mm
Max. scan depth		60mm	100mm	100mm	65mm
Stand-off		240mm	282mm	282mm	289mm
Scanning error *		12μm	15μm	18μm	17μm
Max. Acquisition rate		75,000 points/sec			3×25,500 points/sec
Mass		430g	400g	400g	480g
Laser Class	EN/IEC	Class2 [EN/IEC 60825-1(2007)]			
	JIS	Class2 [JIS C 6802 : 2011]			
	Laser type	Red semiconductor			
Line Laser	Wavelength	660nm			
	Output	4mW			
Point Laser	Wavelength	635nm			—
	Output	1mW			—

	Accuracy inspection environment	Temperature: 20°C±1°C / Humidity: 50%±10%
*	Target workpiece	Specified master ball for inspection (Diameter 30mm)
	Inspection method	According to Mitutoyo's acceptance procedure. (1σ/sphere measurement, probe alone)



606/610/1010



606T

Probe Features and Applications

SurfaceMeasure	Features	Applications
606	The highest-accuracy model in the SurfaceMeasure series	Power train parts, domestic electric parts as well as small parts
610	Greater measuring range in the depth direction than that of series 606 to support deep workpieces	General power train parts, car body inner panels
1010	Greater measuring range in the width direction than that of series 610, thus effective at reducing measuring time	Car body inner panels
606T	Implements 3D measurement using 3 laser beams, thereby reducing the frequency of probe attitude change	Transmission cases, sheet metal, car body inner panels

Measuring Range

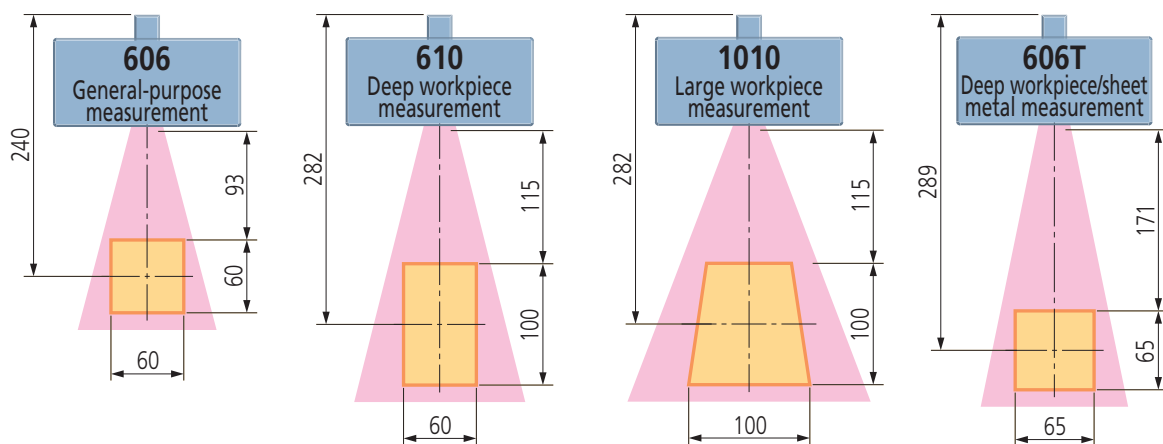

Non-contact Line-Laser Probe by Mitutoyo Quality

Now you can measure a workpiece without being concerned about its color tone or glossiness.

Powder-sprayless measurement and high-speed scanning

The SurfaceMeasure is a lightweight, high-performance, non-contact, line-laser probe developed for use with CNC coordinate measuring machines. The use of digital signals has eliminated the effects of signal deterioration on measurement accuracy and also improved measuring speed. Furthermore, by automatically adjusting the laser intensity and camera sensitivity according to the environment and the workpiece material, the SurfaceMeasure has achieved powder-sprayless measurement, providing a simpler and more comfortable laser-scanning environment. The large amount of measurement point data (point cloud) provided by laser scanning facilitates creation of accurate CAD models from legacy parts. SurfaceMeasure probes can be used not only for dimensional measurement but also for modeling from point group data using commercial software, structural/fluid analysis and data transfer to a molding machine as a tool for digital engineering.

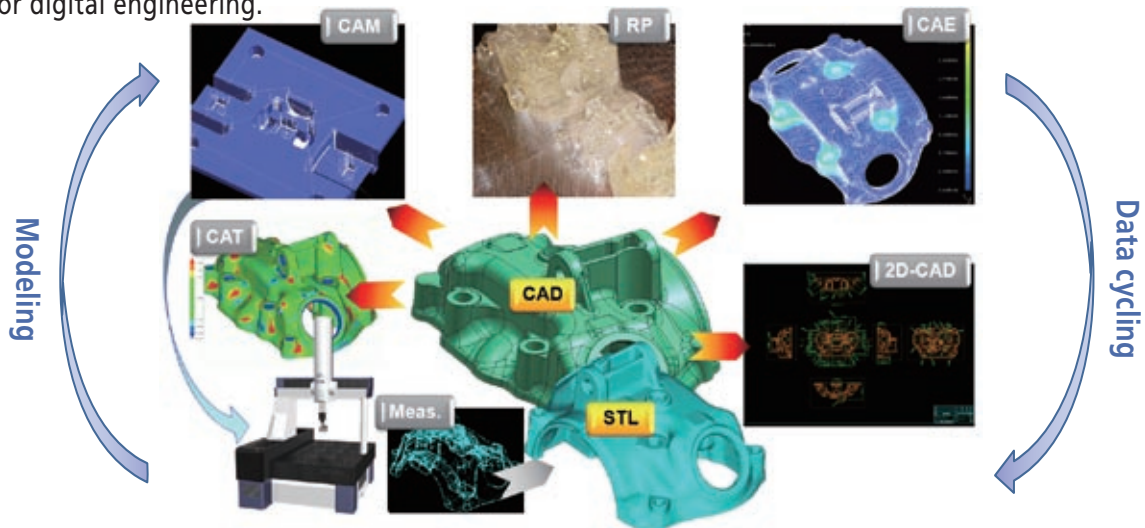

Features of Non-contact CMM by 3 Keywords:

Reliability

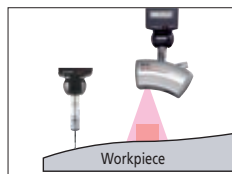

- Based on a CMM that supports quality assurance operations.
- Allows the verification of non-contact measurement data with a contact probe.

Hybrid measurement

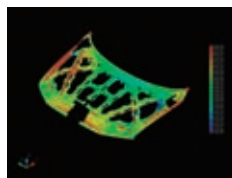

- Visualizes a shape that was previously invisible by establishing a plane from measured points.
- Allows interchange between contact and non-contact probes according to the required measuring accuracy or workpiece shape.

Fully automatic measurement



- Automatic probe change with a probe changing rack.
- Allows programming a series of jobs from measurement to report creation.

High-speed scanning

- Positioning control in a maximum of 720 directions enables high-speed scanning of even complex workpieces in the optimum orientation. Additionally, the use of ACR3* allows you to make fully automated measurements while selecting "non-contact" and "contact" probes as desired.



- Using the ACR3 equipped with a power supply port for the laser probe, which can be specially ordered, eliminates the need for warming up the laser probe. *ACR3 is a trademark of Renishaw plc.
- The SurfaceMeasure, with a laser line width of 60 mm, captures data at the rate of 75 lines/sec.

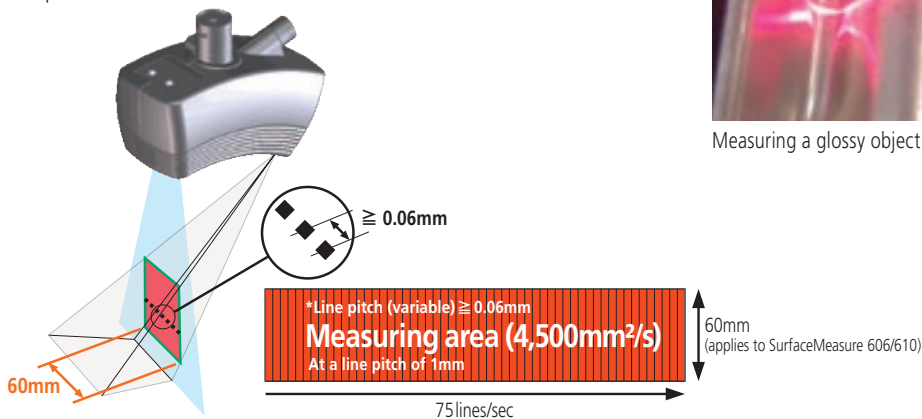

- The line laser crossing type enables simultaneous scanning by 3 laser beams, thus allowing efficient measurement of even complicated shapes. (Applies to SurfaceMeasure 606T)

Improvement in measurement efficiency by reducing the frequency of probe attitude change

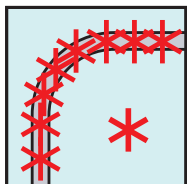

No change of probe attitude

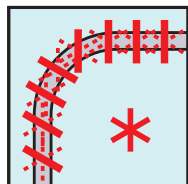

Individual beam selectable

Simultaneous measurement of top and side by concurrently scanning 3-directional laser beams

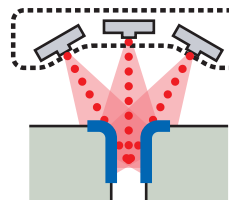

The laser beams converge from 3 directions toward a central point.



Powderspray-less measurement

- Since the laser intensity and camera sensitivity are automatically adjusted, stable shape data can be obtained even when the workpiece has multiple colors and varying degrees of reflectance.



Measuring a color-sample plate

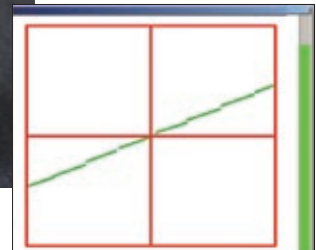

Measuring a glossy object

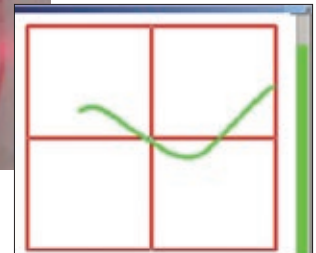

Off-line teaching software to improve work efficiency

If model data is available, you can create measurement macros even if you don't have the actual workpiece.

Off-line teaching: MSURF-G

Since MSURF-G can use model data to create measurement macros, measurement operations can start immediately when the actual object is ready.

MSURF-G increases the availability factor of measuring machines and, when combined with MSURF-I, significantly reduces the number of process steps in everything from measurement to product evaluation.

- Reduces the time the CMM was previously occupied in the creation of measurement macros.
- Allows easy creation of measurement macros, regardless of the skill level of the operator.
- Optimizes workflow from measurement to evaluation.

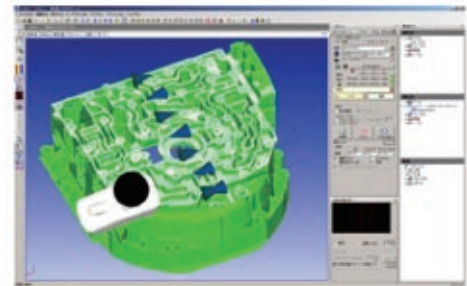

■ Semi-automatic function for creating measurement paths with optimum probe orientation

- To create a measurement path, simply specify a single point on the model.
- The optimum scanner orientation is automatically selected.
- This function creates new measurement paths while avoiding areas where measurement paths have already been created.

*On sheet metal, the semiautomatic function can be used on approximately 95% of the entire area.

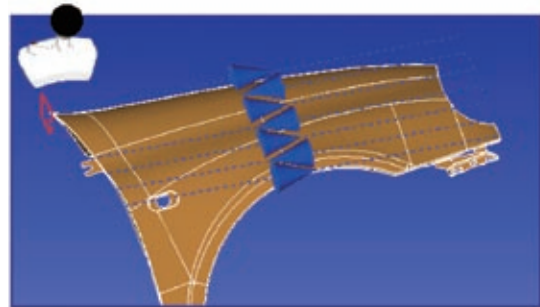

■ Generation of simulated data for the point cloud data expected to be obtained through scanning

- Creates point cloud data on work models while adjusting for the measurement conditions (scanner orientation, measurement pitch, overlap, etc.), the camera's blind spots (the laser projection direction and the position of the model), and the scanner conditions (effective field of view, reflection angle, etc.).



■ Displaying measurement movements (scanner movements) in animation

- Replays the measurement movements at an appropriate speed by adjusting for the type of scanner being used and the stripe pitch.
- A slider can be used to adjust the speed at which the scanner movements are displayed. The animation can also be advanced or reversed.

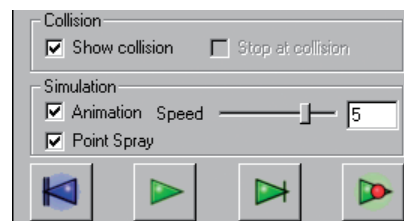

- Detection of collision between the “laser probe + probe head” and the model
- When a collision is detected, the collision area is displayed in red and the collision information is output in an inspection tree.
 - *Collision with the spindle cannot be detected.

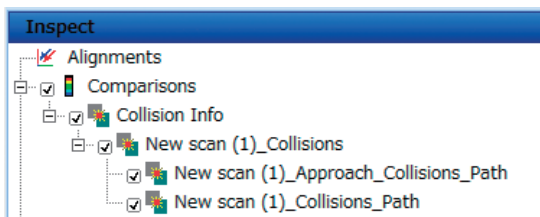

Output of scan information containing a detected collision.

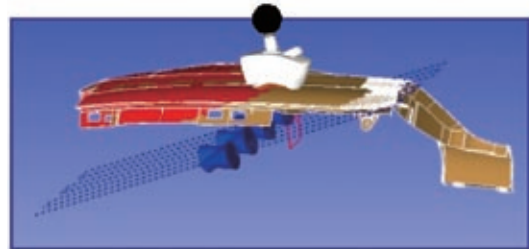
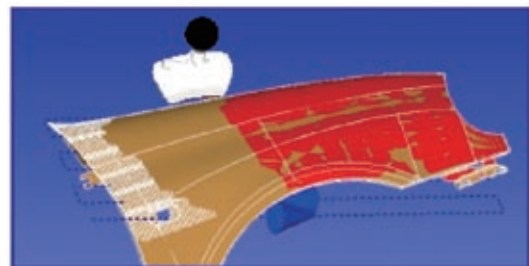

When a collision is detected, the area is displayed in red.

- When a measurement macro is created, the macro execution time is estimated. This time is calculated from the measurement conditions and the coordinate measuring machine used, resulting in a value close to the actual time.

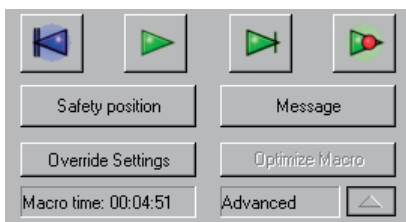

Macro time: 00:04:51

Providing Measurement Solutions with Non-Contact Line-

Reducing the measurement, inspection, and analysis processes through high-speed data collection.

User-friendly point cloud data processing software

Evaluation based on non-contact measurement begins with the process of accurately capturing the surfaces of the product that has been formed.

The high-density point cloud data obtained from the surface of a part is utilized by evaluation software programs for data analysis purposes, such as extraction of geometric elements, evaluation of free-form surfaces and profile shapes, and comparison with master data.

Furthermore, utilizing the obtained data in reverse engineering can revitalize the creative and manufacturing cycle that uses 3D data as its core.

*MSURF series operates with WindowsXP(32bit) or Windows7(32bit), Windows7(64bit) as of September 2013.

Scanning: MSURF-S

■ Scanning paths can be created by simply defining three items: the scanning starting point, the scanning length, and the scanning width.

- You can easily define these three items using the joystick while checking the camera preview.
- If point cloud data or master data is displayed on the screen, you can define the three items using the mouse on the data. This feature is convenient for creating a measurement path based on simulation and for specifying areas where data needs to be re-measured, both of which are useful in reducing the number of measurement steps. These operations can be easily carried out using the joystick.

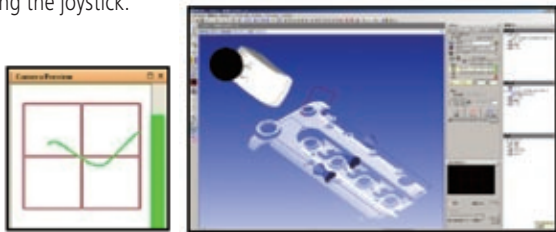

■ Scanning paths can be registered as measurement macros.

- You can use the override function to modify all or some of the measurement conditions in the created measurement macros.
- The submacro function is effective for measuring multiple units of the same workpiece.
- The execution time of a measurement macro is computed from the measurement conditions and the coordinate measuring machine specifications.

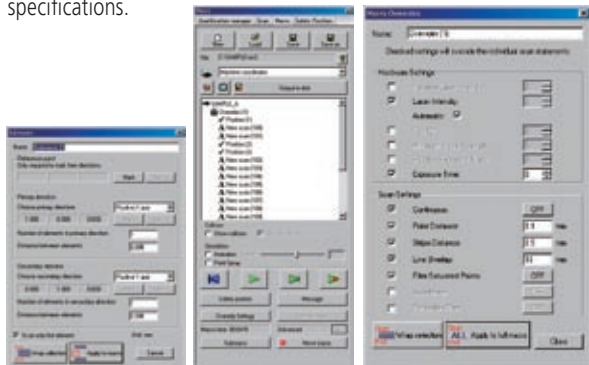

- It allows setting and execution of scanning paths and registration and deletion of the macro by using the joystick.



* Function newly added from MSURF V2.011.

Since measurement can be performed without PC operation, measurement efficiency is dramatically improved, particularly for large Coordinate Measuring Machines.

■ MSURF-S can be started from MCOSMOS

- Since a work coordinate system created in MCOSMOS can be utilized by MSURF-S, you can execute fully automatic measurements that merge "contact" and "non-contact" measurements.

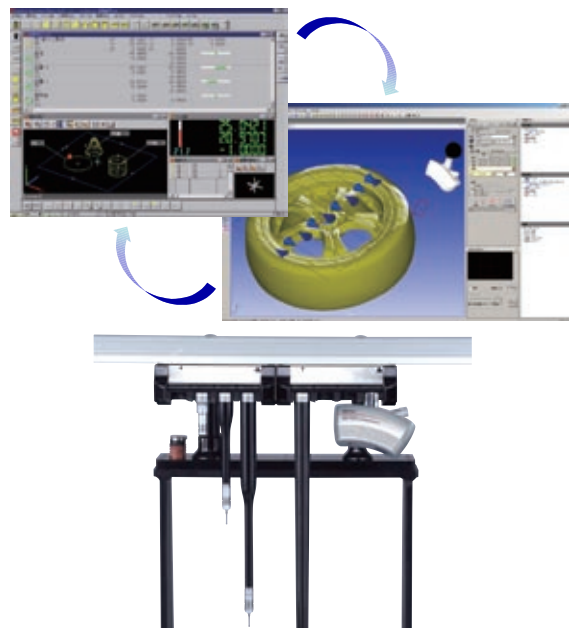

Note: If ACR3 is not used, the probe must be manually changed.

Laser Probes to Strengthen Manufacturing Capability

Enabling easy measurement of curved shapes, producing data that can be used in reverse engineering.

Inspection: MSURF-I

■ Importing CAD data

- Support of IGES, STL, and SAT formats is standard.
- Optional formats available include CATIA V4, CATIA Variable, ProEngineer, Unigraphics, STEP, and VDAFS.

■ Feature-by-feature comparison

- You can detect various features from point cloud data or mesh data and compare them to the design data. From features containing point data, such as a circle, you can calculate the dimensions between the features.
- Features that can be detected include the basic elements such as planes, points, straight lines, slots, cylinders, circular cones and spheres as well as welded bolts, welded nuts, cylindrical pins, T-studs, etc.

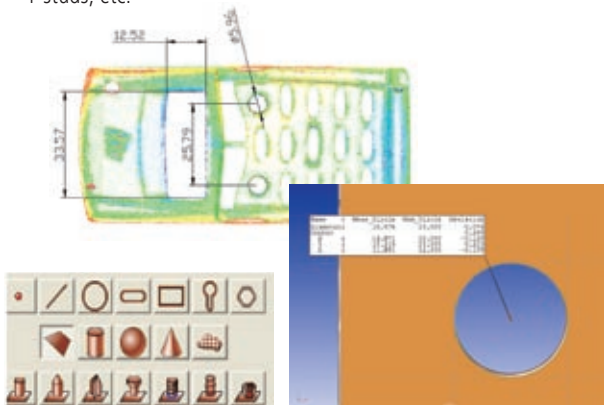

■ Comparison of cross-sectional shapes

- You can cut point cloud data or mesh data to compare cross-sectional shapes or compute angles, distances, radii, etc.
- Additionally, the optional turbine blade analysis function can compute the LE thickness, TE thickness, maximum thickness, chord length, etc.

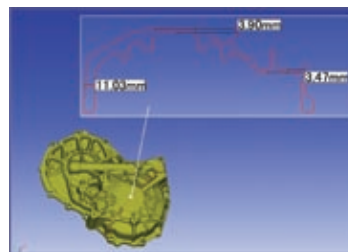

Cross-sectional evaluation (dimension computation)

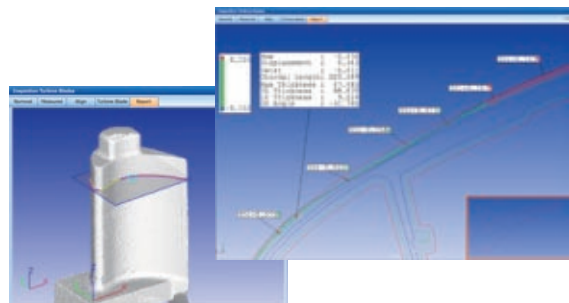

Turbine blade analysis (optional function)

■ Planar shape comparison

- Point cloud data or mesh data can be compared with CAD data, and the planar shape errors displayed on a color map.
- Since wall thicknesses can be displayed on a color map, there is no need to cut the workpiece as is necessary with conventional methods.
- A simulated digital caliper function enables quick evaluation of a wide variety of steps and gaps.
- When evaluating the curvature of a surface, the angle R within the specified tolerance, for example, can be evaluated.

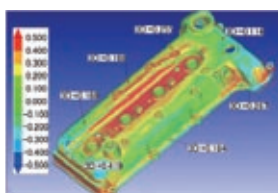

Color map of errors

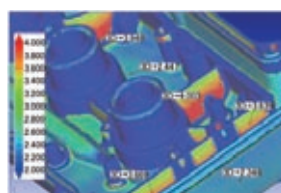

Color map of wall thickness

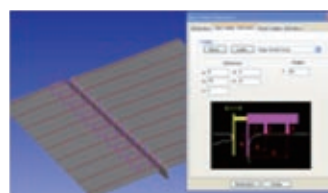

Evaluation of steps and gaps



Evaluation of surface curvature



Export permission by the Japanese government may be required for exporting our products according to the Foreign Exchange and Foreign Trade Law. Please consult our sales office near you before you export our products or you offer technical information to a nonresident.

- Coordinate Measuring Machines
- Vision Measuring Systems
- Form Measurement
- Optical Measuring
- Sensor Systems
- Test Equipment and Seismometers
- Digital Scale and DRO Systems
- Small Tool Instruments and Data Management

Mitutoyo Corporation
 20-1, Sakado 1-Chome,
 Takatsu-ku, Kawasaki-shi,
 Kanagawa 213-8533, Japan
 T +81 (0) 44 813-8230
 F +81 (0) 44 813-8231
<http://www.mitutoyo.co.jp>



Note: All information regarding our products, and in particular the illustrations, drawings, dimensional and performance data contained in this pamphlet, as well as other technical data are to be regarded as approximate average values. We therefore reserve the right to make changes to the corresponding designs, dimensions and weights. The stated standards, similar technical regulations, descriptions and illustrations of the products were valid at the time of printing. Only quotations submitted by ourselves may be regarded as definitive.
 Our products are classified as regulated items under Japanese Foreign Exchange and Foreign Trade Law. Please consult us in advance if you wish to export our products to any other country. If the purchased product is exported, even though it is not a regulated item (Catch-All controls item), the customer service available for that product may be affected. If you have any questions, please consult your local Mitutoyo sales office.