

Micro Vickers Hardness Testing Machines HM-200 Series

Catalog No.E17003



Mitutoyo

Micro Vickers Hardness Testing Machines HM-200 Series

Equipped both with the latest optical system ideal for measuring the dimensions of indentation and a test-force loading device that lets you set the test force. The HM-200 series is ideal for quality control and mechanical characteristic evaluation using Vickers hardness testing of small areas.



Features



- Touch-panel operation
- Measurement of indentation dimensions using a measuring microscope
- Positioning using a manual XY stage unit

images
desired test force!



Features

- Operation using AVPAK
- Automatic measurement of indentations
- Positioning using a manual XY stage

	System A	System B
Functions		
Focusing	Manual	Manual
Testing action	Single point	Single point
Test-point positioning	Manual XY stage	Manual XY stage
Measuring indentations	Measuring microscope	Automatic (AVPAK)
Camera (for observing and measuring indentations)	Monochrome, 300,000 pixels*	Color, 3 million pixels
Operating the main unit	Touch panel	PC (AVPAK)

*When a video camera unit is used (pixel count of the camera itself: 380,000)

HM-210/220 Manual model main unit

High-functionality model for Systems A

Measuring microscope

Microscope for measuring indentation dimensions
Integrated 10X eyepiece (810-354 video camera unit can be installed)

New

LED illumination unit

Uses an LED illumination unit that offers a long service life and low power consumption.
LED illumination reduces the time lost during the light bulb replacement required with conventional illumination units.

Automatic turret mechanism

The positions of the indenter and the objective lens can be automatically switched using touch panel operation (can also be manually switched).
Up to four objective lenses can be installed.
Up to two indenter shaft units can be installed.

Interfacing to external instruments

Provided with a wide variety of interfaces to suit any purpose
Test results can be printed on a printer or output to a PC.

- USB 2.0 interface (for data communication)
For PC (EXPAK ver6)
- Digimatic interface
For DP-1VR, U-WAVE, and USB-ITN
- Serial interface
For DPU-414

Wide range of test force

Use of an electromagnetic method makes it possible to set the desired test force, between 0.4903 mN and 19610 mN. (HM-220)

New

Objective lenses provide a long working distance

Six MH Plan objectives are available. The 10X, 20X, 50X, and 100X types are used when measuring indentations, and the 2X and 5X for widefield observation tasks.

Manual XY stage unit with digital micrometer head

During test-site positioning, the positional information is displayed digitally and can also be displayed on the touch panel display controller
25 × 25 mm or 50 × 50 mm stroke can be selected.

Color touch panel controller

Touch panel operations for controlling hardness testing provide a full suite of basic functions necessary for hardness testing, a function for converting the hardness value into various types of hardness scales, and a statistical calculation function

Video camera unit 810-354

(Can be installed in the manual model main unit)

CCD camera and 8.4-inch TFT monitor
Enables observation and measurement of indentations at high magnification, thereby reducing operator error



Mitutoyo

HM-210/220 System model main unit

High-functionality model for Systems B

Measuring microscope (Can be installed as an option)

Enables magnified observation and measurement of indentations.
(The vision unit integrated in the system model main unit and the measuring microscope cannot be simultaneously used for observation.)

New

LED illumination unit

Uses an LED illumination unit that offers a long service life and low power consumption.
LED illumination reduces the time lost during the light bulb replacement required with conventional illumination units.

Automatic turret mechanism

The positions of the indenter and the objective lens can be automatically switched from a PC (AVPAK) (can also be manually switched). Up to four objective lenses can be installed.
Up to two indenter shaft units can be installed.

New

Vision unit

USB color mega-pixel camera
A 3-million pixel, 1/2-inch color USB camera is used for the system model.

Wide range of test force

Use of an electromagnetic method makes it possible to set the desired test force very accurately, between 0.4903 mN and 19610 mN. (HM-220)

New

Objective lenses provide a long working distance

Six MH Plan objectives are available. The 10X, 20X, 50X, and 100X types are used when measuring indentations, and the 2X and 5X for widefield observation tasks.
2X and 5X for wide-field observation

Manual XY stage unit with digital micrometer head (System B)

During test-site positioning, the positional information is displayed digitally.
25 × 25 mm or 50 × 50 mm stroke can be selected.



connection



AVPAK software for automatic hardness testing systems

Software that supports control, testing, and report creation related to hardness testing
Supports parameter setting and automatic measurement.

High-functionality PC and TFT monitor

Compatible with Windows 7 Professional 32-bit
Supports a wide-screen TFT and provides improved operability.

New

HM-200 Series AVPAK software for controlling Systems B

Screen layout for control, testing status, and result display can be changed freely.

Graphic view (of stored images)

For displaying the entire specimen and checking the pattern positioning
The digital zoom function can be used to easily magnify and check the site being tested.

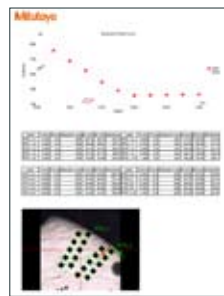
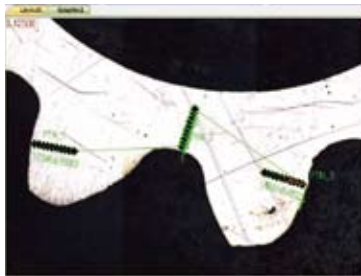

Layout view

Photos from individual views, graphs, tables, etc., can be laid out freely to help with report creation.

Part program

Automatically records the sequence of operations in a test
To repeat the same test, the part program can be called up for repeated execution.

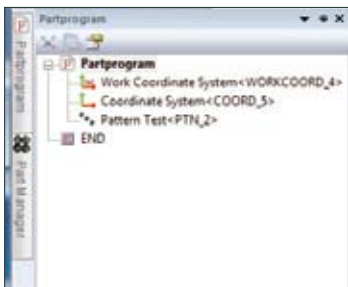

Parts manager

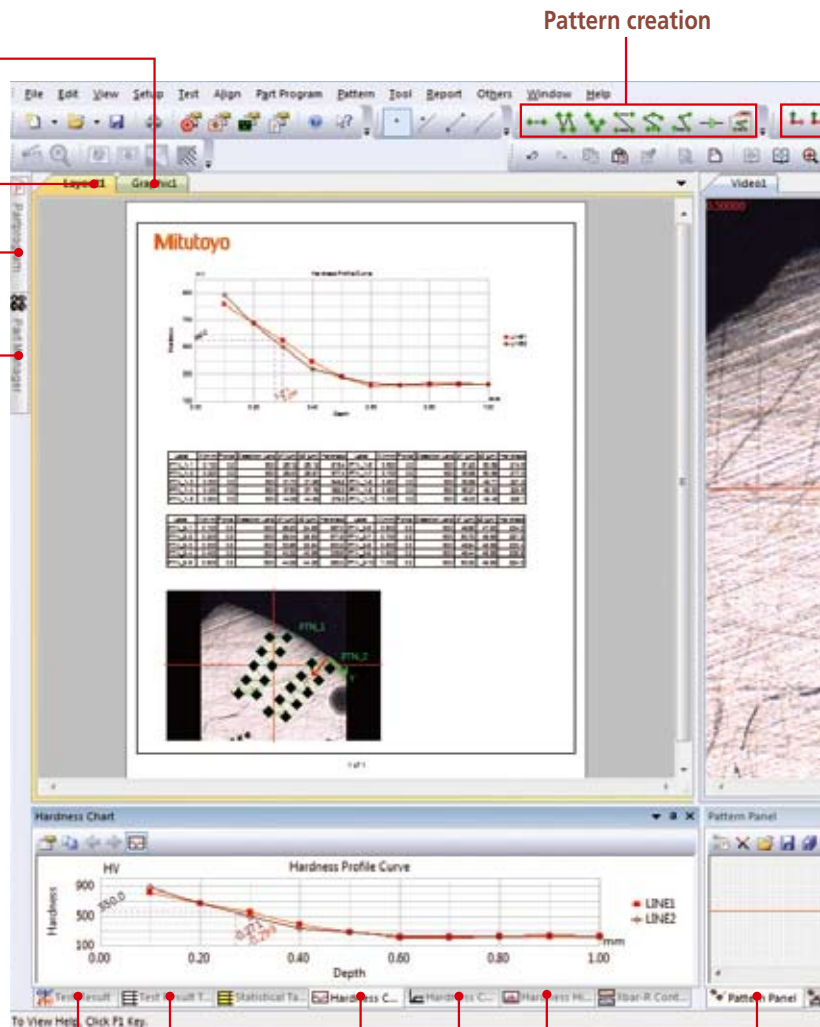

Pattern creation

Test result list view

Test result view

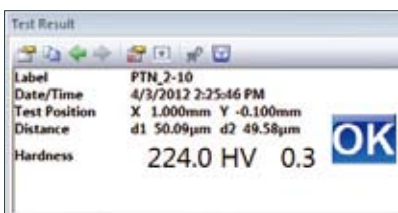

Hardness curve graph

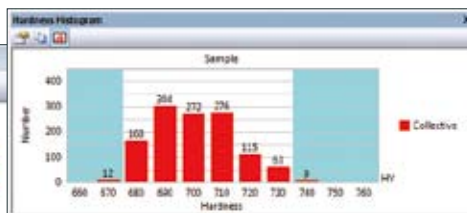

Hardness distribution diagram

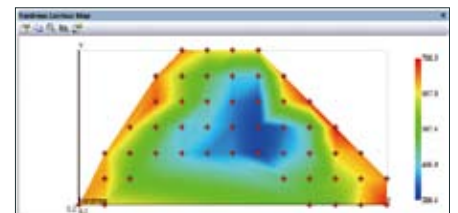

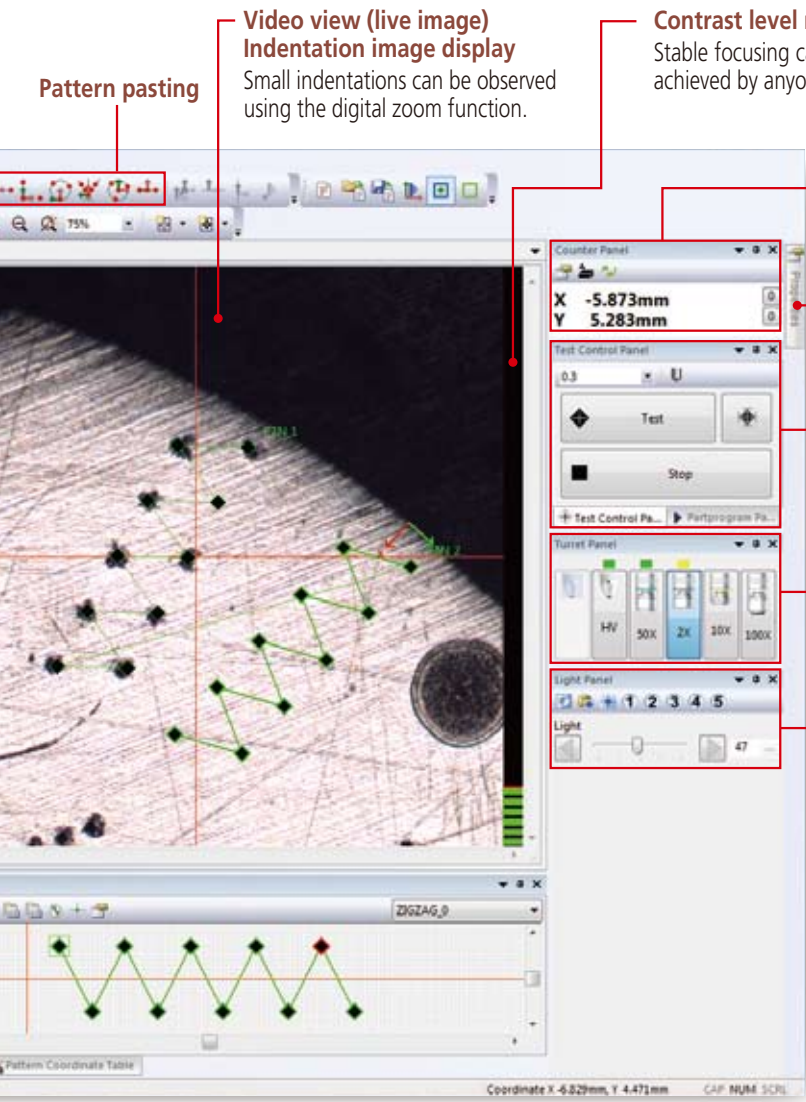

Pattern pasting

**Video view (live image)
Indentation image display**
Small indentations can be observed using the digital zoom function.

Contrast level meter
Stable focusing can be easily achieved by anyone.

Counter
Displays the stage's current coordinates.

Property panel

Test control
Controls testing actions such as wide- or narrow-range auto-focusing and measurement of indentations.

Turret control
Switches the objective lens and indenter shaft

Illumination control
Controls the illumination in 100 steps

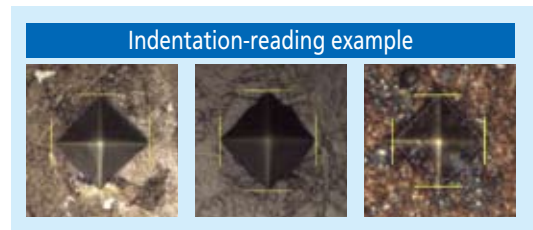

Pattern panel



Frequency distribution graph

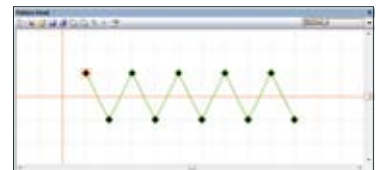
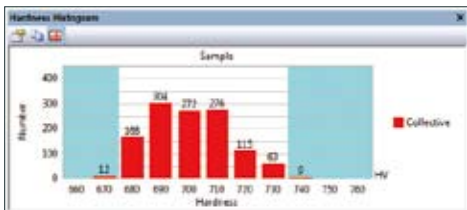

HM-200 Series AVPAK software for controlling Systems B

New functions



Pattern creation

This tool supports the creation of test patterns such as straight lines, zigzag lines, and teaching patterns.



Pattern pasting

This tool supports the pasting of created test patterns. It adjusts the origin, direction, etc., to paste a pattern.

Handling of multiple specimens

Multiple specimens can be tested when a part program and Parts Manager are used.

Parts Manager

Executes a common part program for specimens having the same shape



Reading of indentations

Improvement in image-processing performance has improved the indentation measurement function.

*measurement accuracy varies according to conditions.

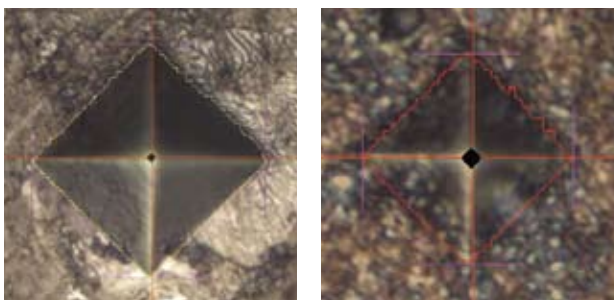

Indentation depth display

Displays the indentation depth of the diamond indenter while the testing force is being applied. (Reference value)

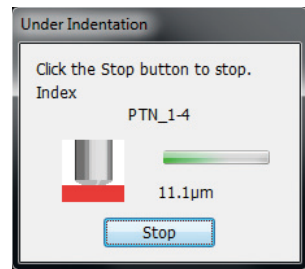
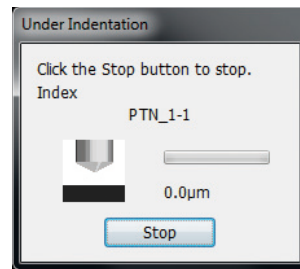

Property panel

Used for setting the test conditions such as the test force and load time, as well as the indentation measurement condition.



Navigation function

When the test position is being moved during multi-point testing, this function guides the travel of the XY fine adjustment manual stage to the next position.



HM-200 Series Touch-panel control screen & System outline drawing

Touch-panel control screen

Easy-to-understand graphic display enables intuitive operation. Functions for converting values and compensating for curved surfaces, as well as a test condition guiding function are all provided as standard features.
(Installed in the manual model main unit)

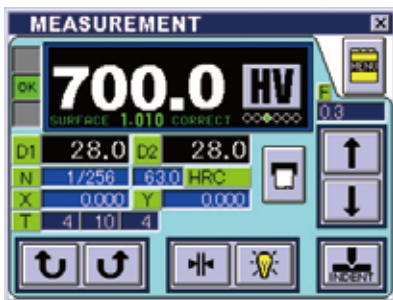

Displays test conditions and test results.

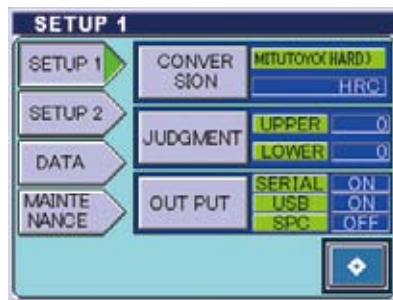

Used for selecting a conversion scale, entering a setting for Pass/Fail determination, and specifying external output.



Used for selecting a conversion scale, entering a setting for Pass/Fail determination, and specifying external output.

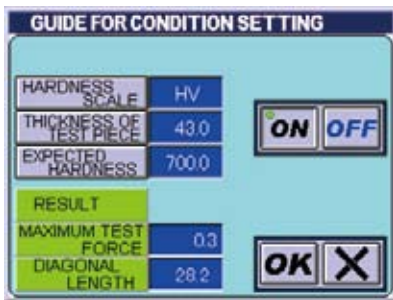

By entering the specimen thickness and the presumed hardness, you can set a test force that satisfies the JIS conditions.



In addition to the test force dwell time, you can specify loading and unloading testing actions.



You can check the test results in a statistical list.

System A Outline drawing

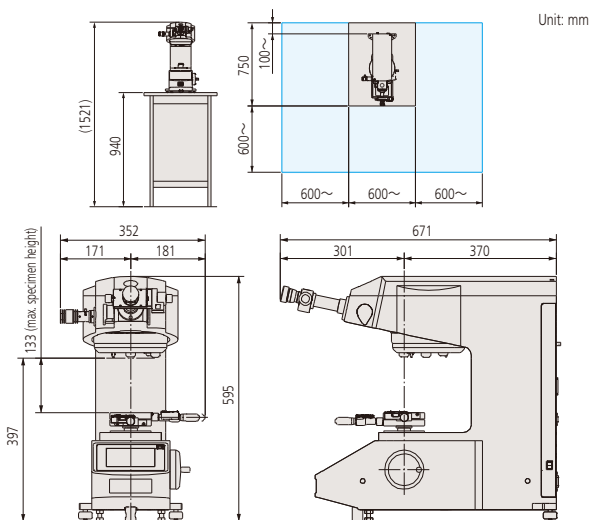

* When the 25 × 25 mm manual XY stage is used

System B Outline drawing

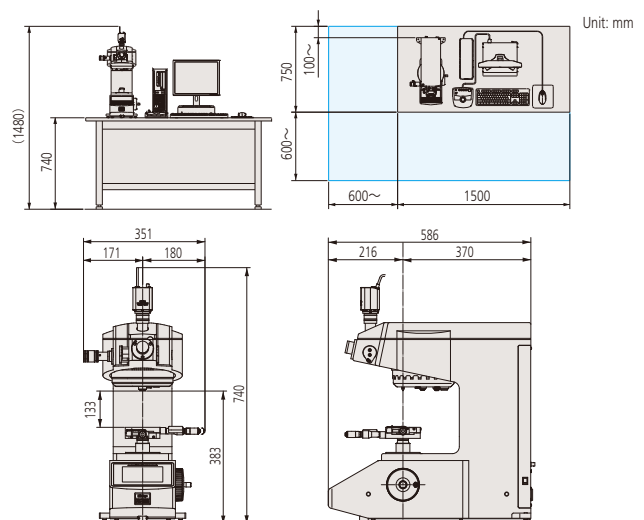

* When the 25 × 25 mm manual XY stage is used

System configurations

	Code No.	Item name	System A	System B	Details	Notes	
Main unit	810-400*	HM-210 manual model main unit	○	×	Standard test force, measuring microscope, with a 50X lens		
	810-405*	HM-220 manual model main unit	○	×	Low test force, measuring microscope, with a 50X lens		
	810-403*	HM-210 system model main unit	×	○	Standard test force, with a 50X lens	No measuring microscope, No touch panel	
	810-408*	HM-220 system model main unit	×	○	Low test force, with a 50X lens		
Factory-installed options	11AAC104	Objective lens unit 2X		○	Objective lens, with lens holder	Up to three additional lenses can be selected (maximum of four lenses can be installed in the main unit)	
	11AAC105	Objective lens unit 5X		○	Objective lens, with lens holder		
	11AAC106	Objective lens unit 10X		○	Objective lens, with lens holder		
	11AAC107	Objective lens unit 20X		○	Objective lens, with lens holder		
	11AAC108	Objective lens unit 100X		○	Objective lens, with lens holder		
	11AAC109	Indenter shaft unit for HM-210		○	With 19BAA061 knoop indenter	Double-indenter specification	
	11AAC110	Indenter shaft unit for HM-220		○	With 19BAA062 knoop indenter	Double-indenter specification	
	11AAC129	Measuring microscope (which can be added)	×	○		Cannot be used simultaneously with the VISION UNIT	
	810-354*	Video camera unit	○	△	Monochrome 300,000-pixel camera, 8.4-inch TFT, with a stand	△: Installation requires a measuring microscope. Provided on a special order basis	
Essential options	810-420	Manual XY stage unit 25X25					
	810-423	Manual XY stage unit 50X50					
	810-424	Manual XY stage unit 1"x1"	☆	☆			
	810-427	Manual XY stage unit 2"x2"					
	11AAC063	AVPAK v1 J	×	☆		Selected according to the delivery destination	
	11AAC064	AVPAK v1 E					
Special accessories	810-016	Standard vise		○	Jaw opening: 51 mm		
	810-017	Special vise		○	Jaw opening: 100 mm		
	810-013	Thin plate specimen holder		○	Thickness: Max. 5 mm		
	810-014	Slender specimen holder (horizontal)		○	Diameter: 0.4-3 mm		
	810-015	Slender specimen holder (vertical)		○	Diameter: 0.4-4 mm		
	810-019	Specimen-tilting holder		○	Jaw opening: 37 mm, Tilting angle: ±15° , Rotating angle: ±25°		
	810-020	Universal specimen holder		○	Thickness: Max. 30 mm		
	810-018	Turntable		○	Minimum graduation: 1°		
	810-085	Adjustable thin-plate specimen holder		○	Thickness: Max. 3 mm, Width: Max. 56 mm		
	810-095	Rotatable tilting specimen holder		○	Height: Min. 20 mm, Width and diameter: 15-55 mm		
	810-870*	Specimen heater HST-250	○	△		△: Cannot be automatically read with AVPAK	
	810-650-1	Resin-molded specimen holder Ø25.4		○	Ø25.4±0.5 mm Specimen height: 9-39 mm		
	810-650-2	Resin-molded specimen holder Ø30		○	Ø30±0.5 mm Specimen height: 9-39 mm		
	810-650-3	Resin-molded specimen holder Ø31.75		○	Ø31.75±0.5 mm Specimen height: 9-39 mm		
	810-650-4	Resin-molded specimen holder Ø38.1		○	Ø38.1±0.5 mm Specimen height: 9-39 mm		
	810-650-5	Resin-molded specimen holder Ø40		○	Ø40±0.5 mm Specimen height: 9-39 mm		
	19BAA061	Knoop indenter (for standard test force)		○		Can be selected to replace the Vickers indenter provided as a standard accessory.	
	19BAA062	Knoop indenter (for low test force)		○			
	375-056	Objective micrometer	×	○	Scale graduation: 1 mm, Minimum graduation: 0.01 mm	For magnification calibration	
	Printers	02AGD600*	Model DPU-414 (with a connection cable)	○	×	Receipt printer	For 100V
		264-504*	Model DP-1VR	○	×	Digimatic mini-processor	
		936937	Connection cord	○	×	For DP-1VR 1 m	
		02AZD810D	U-WAVE-R	○	×		
		02AZD880D	U-WAVE-T	○	×	Buzzer type	
		02AZD790D	Dedicated connection cable for U-WAVE-T	○	×		
		06ADV380D	USB-ITN-D	○	×	Flat 10-pin	PC must be provided separately.
—		EXPAK ver6	○	×		Requires Microsoft Excel 2010	
Others	02ATE760	Table		○	1800 (W) x900 (D) x740 (H)	For tester and PC	
	998923	System rack (vertical)		○		Only a PC can be mounted.	
	810-641	Vibration isolator		○		Only the tester can be mounted.	
	810-644	Wing for vibration isolator		○	For 810-641	Recommended if the video camera unit is to be attached	
	11AAC146	Plate for preventing toppling		○			

○: Selectable ☆: One of each type must be selected from the choice offered ×: Cannot be selected △: Contact Mitutoyo Sales Dept.
 Note: A suffix replaces the * symbol.

■ Specifications Main Unit

Model name			HM-210A	HM-210B																																							
Main unit	HM-210 manual model main unit	810-401*	○	—																																							
	HM-210 system model main unit	810-403*	—	○																																							
Hardness tester	Applicable standards	JIS B 7725 / ISO 6507-2																																									
	Test force	<table border="1"> <thead> <tr> <th>Hardness symbol</th> <th>HV0.01</th> <th>HV0.02</th> <th>HV0.03</th> <th>HV0.05</th> <th>HV0.1</th> <th>HV0.2</th> <th>HV0.3</th> <th>HV0.5</th> <th>HV1</th> </tr> </thead> <tbody> <tr> <td>N</td> <td>98.07x10⁻³</td> <td>196.1x10⁻³</td> <td>294.2x10⁻³</td> <td>490.3x10⁻³</td> <td>980.7x10⁻³</td> <td>1.961</td> <td>2.942</td> <td>4.903</td> <td>9.807</td> </tr> <tr> <td>(gf)</td> <td>(10)</td> <td>(20)</td> <td>(30)</td> <td>(50)</td> <td>(100)</td> <td>(200)</td> <td>(300)</td> <td>(500)</td> <td>(1000)</td> </tr> </tbody> </table>	Hardness symbol	HV0.01	HV0.02	HV0.03	HV0.05	HV0.1	HV0.2	HV0.3	HV0.5	HV1	N	98.07x10 ⁻³	196.1x10 ⁻³	294.2x10 ⁻³	490.3x10 ⁻³	980.7x10 ⁻³	1.961	2.942	4.903	9.807	(gf)	(10)	(20)	(30)	(50)	(100)	(200)	(300)	(500)	(1000)											
	Hardness symbol	HV0.01	HV0.02	HV0.03	HV0.05	HV0.1	HV0.2	HV0.3	HV0.5	HV1																																	
	N	98.07x10 ⁻³	196.1x10 ⁻³	294.2x10 ⁻³	490.3x10 ⁻³	980.7x10 ⁻³	1.961	2.942	4.903	9.807																																	
	(gf)	(10)	(20)	(30)	(50)	(100)	(200)	(300)	(500)	(1000)																																	
Indenter approach speed	Fixed at 60 μm/s																																										
Test force loading time	1- 99s Can be set in 1s increments.																																										
Test force dwell time	0-999s Can be set in 1s increments.																																										
Test force unloading time	1- 99s Can be set in 1s increments.																																										
Model name			HM-220A	HM-220B																																							
Main unit	HM-220 manual model main unit	810-405	○	—																																							
	HM-220 system model main unit	810-408	—	○																																							
Hardness tester	Applicable standards	JIS B 7725 / ISO 6507-2																																									
	Test force	<table border="1"> <thead> <tr> <th>Hardness symbol</th> <th>HV0.0005</th> <th>HV0.001</th> <th>HV0.002</th> <th>HV0.003</th> <th>HV0.005</th> <th>HV0.01</th> <th>HV0.02</th> <th>HV0.03</th> <th>HV0.05</th> <th>HV0.1</th> </tr> </thead> <tbody> <tr> <td>N</td> <td>0.4903x10⁻³</td> <td>0.9807x10⁻³</td> <td>1.961x10⁻³</td> <td>2.942x10⁻³</td> <td>4.903x10⁻³</td> <td>9.807x10⁻³</td> <td>19.61x10⁻³</td> <td>29.42x10⁻³</td> <td>49.03x10⁻³</td> <td>98.07x10⁻³</td> </tr> <tr> <td>(gf)</td> <td>(0.05)</td> <td>(0.1)</td> <td>(0.2)</td> <td>(0.3)</td> <td>(0.5)</td> <td>(1)</td> <td>(2)</td> <td>(3)</td> <td>(5)</td> <td>(10)</td> </tr> </tbody> </table>	Hardness symbol	HV0.0005	HV0.001	HV0.002	HV0.003	HV0.005	HV0.01	HV0.02	HV0.03	HV0.05	HV0.1	N	0.4903x10 ⁻³	0.9807x10 ⁻³	1.961x10 ⁻³	2.942x10 ⁻³	4.903x10 ⁻³	9.807x10 ⁻³	19.61x10 ⁻³	29.42x10 ⁻³	49.03x10 ⁻³	98.07x10 ⁻³	(gf)	(0.05)	(0.1)	(0.2)	(0.3)	(0.5)	(1)	(2)	(3)	(5)	(10)								
	Hardness symbol	HV0.0005	HV0.001	HV0.002	HV0.003	HV0.005	HV0.01	HV0.02	HV0.03	HV0.05	HV0.1																																
	N	0.4903x10 ⁻³	0.9807x10 ⁻³	1.961x10 ⁻³	2.942x10 ⁻³	4.903x10 ⁻³	9.807x10 ⁻³	19.61x10 ⁻³	29.42x10 ⁻³	49.03x10 ⁻³	98.07x10 ⁻³																																
	(gf)	(0.05)	(0.1)	(0.2)	(0.3)	(0.5)	(1)	(2)	(3)	(5)	(10)																																
Indenter approach speed	Variable between 2 and 60 μm/s Can be set in 1 μm/s increments (only for 30 gf or smaller; Fixed at 60 μm/s for 31 gf or greater)																																										
Test force loading time	1- 99s Can be set in 1s increments.																																										
Test force dwell time	0-999s Can be set in 1s increments.																																										
Test force unloading time	1- 99s Can be set in 1s increments.																																										
Mechanism	Loading device	Test force control	Electromagnetic (voice coil)																																								
		Test force switching	Can be selected from touch panel																																								
	Turret	Drive method	Motor drive																																								
		Operation method	Touch panel / Manual	AVPAK / Manual																																							
Number of turret ports	Indenter shaft unit: Up to two can be installed (including the standard Vickers indenter shaft unit already installed); Objective lens unit: Up to four can be installed (including the standard 50X objective lens already installed)																																										
Controller	Display content	Indentation value	Integrated touch panel (5.7-inch color LCD)					Data-processing software																																			
		Minimum display unit	D1 D2, max. 5 digits each																																								
		Hardness value	For objective lenses of 50X or higher: 0.01 μm; For lower than 50X: 0.1 μm																																								
		Test condition	Maximum of four digits, Minimum: 0.1 HV/HK, Fracture toughness value																																								
		Test condition	Indenter (HV/HK), test force, loading, dwell, and unloading times																																								
		Compensation	Cylinder, sphere, measurement																																								
	Calculation functions	Pass/Fail determination	OK/±NG																																								
		Other	XY positional data, turret position display, statistical calculation																																								
External connection interface	Maximum specimen dimensions	Language used	Japanese, English, German, French, Italian, Spanish																																								
		Pass/Fail determination function	Determines whether or not the measured hardness is acceptable (OK/±NG) based on the upper and lower limits that have been set.																																								
		Function for guiding measurement condition setup	Enter the indenter, specimen thickness, and presumed hardness to calculate the maximum test force.																																								
		Compensation function	Cylindrical compensation, spherical compensation, measurement compensation																																								
Statistical calculation function	Number of data units, maximum value, minimum value, average, range, upper limit, lower limit, number of passes, number of fails, ultra upper limit and ultra lower limit, standard deviation (n-1), standard deviation (n)																																										
Main unit	External dimensions (excluding protrusions and stage)	For printer: Serial interface (compatible with the RS-232C standard); For Digimatic interface and data communication: USB 2.0																																									
		Maximum specimen depth: 160 mm, Maximum specimen height: 133 mm																																									
Main unit power supply	Maximum load capacity	3kg																																									
	Main unit mass	Approx. 43 kg																																									
Main unit power supply		39VA AC100V: AC100-125V, AC200V: AC220-240V																																									

Note: A suffix replaces the * symbol.

■ Specifications Optical system

Item name	HM-210 manual model main unit	HM-220 manual model main unit	HM-210 system model main unit	HM-220 system model main unit
Optical system	Infinitely corrected optical system, 4-port objective lens switching method			
Tube lens magnification	1x			
Illumination	Light source	White LED		
	Aperture diaphragm	Variable		
Standard objective lens	Lens	MH Plan 50x		
	Working distance [mm]	2.5		
Measuring microscope (Ocular)	Real field of view and imaging range	Real field of view: ø0.14 mm		Imaging range: 0.118 (H) mm x 0.089 (V) mm
		Length-measuring microscope with integrated encoder and eyepiece (10X)		Factory-installed options
Objective lens unit (including holder) (factory-installed options)	MH Plan 2x	MH Plan 5x	MH Plan 10x	MH Plan 20x
Part No.	11AAC104	11AAC105	11AAC106	11AAC107
Working distance [mm]	6	27	11.8	5.2
Measurement range [Ø mm]	3.5 (reference)	1.4 (reference)	0.7	0.35
Imaging range [(H) mm x 0.089 (V) mm] (Vision unit)	2.95x2.21	1.18x0.89	0.59x0.44	0.30x0.22
				0.059x0.044

■ Specifications Manual XY stage unit

Systems A and B

Item name	Manual XY stage unit 1"x1"	Manual XY stage unit 2"x2"	Manual XY stage 25X25	Manual XY stage 50X50
Code No.	810-424	810-427	810-420	810-423
Stage travel range	25.4×25.4mm	50.8×50.8mm	25×25mm	50×50mm
Table size	100×100mm	130×130mm	100×100mm	130×130mm
Minimum display unit	0.001mm/0.0005"		0.001mm	
XY stage dimensions	221 (W) × 221 (D) × 37 (H) mm	305 (W) × 305 (D) × 49 (H) mm	221 (W) × 221 (D) × 37 (H) mm	305 (W) × 305 (D) × 49 (H) mm
XY stage mass	2.5kg	6.6kg	2.5kg	6.6kg

■ Specifications Video camera unit

System A

Item	Description
TFT screen magnification	10X: Approx. 200 times (approx. 260 times)
	50X: Approx. 1000 times (approx. 1300 times)
	100X: Approx. 2000 times (approx. 2600 times)
CCD camera	Imaging method: EIA
	Imaging device: 1/3-inch interline CCD
	External dimensions: 31 (W) × 72.5 (D) × 29 (H) mm Mass: 85g
TFT monitor	Screen size: 210.4 mm diagonal (8.4-inch)
	Number of pixels: 640 (H) × 480 (V)
	Rotation range: 350°
	Tilting range: -5-40°
	Power supply: AC 100-230V/50/60Hz
	Power consumption: 12VA
	External dimensions: 228 (W) × 61.5 (D) × 195 (H) mm [232 (W) × 227 (D) × 426.5 (H) mm (when installed on the stand)]
	Mass: 1.8 g (4.2 kg including the stand)

■ Standard accessories

Code No.	Item name	Specification/Remarks	Quantity
19BAA058	Diamond indenter*1	Vickers for HM-210	1
19BAA059	Diamond indenter*1	Vickers for HM-220	
—	Hardness testing block*2	700HVM0.3 25 mm (diameter) × 6 mm (thickness)	1
—	Indenter shaft unit*1	With Vickers indenter	1
—	Objective lens unit 50X*1		1
19BAA133	Spacer	Material: Bakelite 11 (W) × 42 (D) × 13 (H) mm	1
11AAB405	Extension shaft	For elevation shaft: 38 mm With two set screws	1
11AAB406	Extension shaft	For elevation shaft: 76 mm With two set screws	1
02DEA471	Dust cover	For the hardness tester main unit	1
—	Plastic Phillips screwdriver	No.1300 Phillips 2×100	1
—	Precision flathead screwdriver	No.205 flathead 1.2	1
—	Hex-head screwdriver	1.5 mm	1
—	Hex-head screwdriver	2.5 mm	2
—	Hex wrench	2.5 mm	1
—	Hex wrench	3.0 mm	1
—	Holder	Hanger bolt for the main unit	4
—	Cap*1	Cap for the holder	4
—	Cable clamp	Gray	2
—	Cable clamp	Black	2
—	Spiral tube	Black, approx. 2 m	1
02ZAA000	Power supply cord set -PSE	Classification: Unmarked/C	1
02ZAA010	AC cord set-UL/CSA	Classification: A	
02ZAA020	AC cord set-UL/CSA	Classification: D	
02ZAA030	AC cord set-UL/CSA	Classification: E	
02ZAA040	AC cord set-UL/CSA	Classification: DC	
02ZAA050	AC cord set-UL/CSA	Classification: K	1
99MBG127J	User's manual for the manual model main unit	Japanese	1
99MBG127A	User's manual for the manual model main unit	English	
99MBG137J	User's manual for the system model main unit	Japanese	
99MBG137A	User's manual for the system model main unit	English	
11AAC198	Configuration disk	For the system main unit	
11PAA074	Accessory case		1
—	Certificate for the tester	In both Japanese and English	1
—	Certificate for the hardness test block	In both Japanese and English	1
—	Warranty	In both Japanese and English	1
—	USB camera (system main unit)*1	3 million pixels, 1/2-inch color Systems B	1

*1 Already installed in the main unit when it is delivered.

*2 The numeric values shown are nominal; actual values will be slightly above or below the nominal values.

Mitutoyo Corporation

20-1, Sakado 1-Chome,
Takatsu-ku, Kawasaki-shi,
Kanagawa 213-8533, Japan
T +81 (0) 44 813-8230
F +81 (0) 44 813-8231
<http://www.mitutoyo.co.jp>

Mitutoyo

Export permission by the Japanese government may be required for exporting our products according to the Foreign Exchange and Foreign Trade Law. Please consult our sales office near you before you export our products or you offer technical information to a nonresident.

Coordinate Measuring Machines

Vision Measuring Systems

Form Measurement

Optical Measuring

Sensor Systems

Test Equipment and
Seismometers

Digital Scale and DRO Systems

Small Tool Instruments and
Data Management

Note: All information regarding our products, and in particular the illustrations, drawings, dimensional and performance data contained in this pamphlet, as well as other technical data are to be regarded as approximate average values. We therefore reserve the right to make changes to the corresponding designs, dimensions and weights. The stated standards, similar technical regulations, descriptions and illustrations of the products were valid at the time of printing. Only quotations submitted by ourselves may be regarded as definitive.

Our products are classified as regulated items under Japanese Foreign Exchange and Foreign Trade Law. Please consult us in advance if you wish to export our products to any other country. If the purchased product is exported, even though it is not a regulated item (Catch-All controls item), the customer service available for that product may be affected. If you have any questions, please consult your local Mitutoyo sales office.