



Product Information
Version 1.0

ZEISS Axio Lab.A1

TÜV-Certified Ergonomics for Your Efficient Day in the Laboratory



TÜV-Certified Ergonomics for Your Efficient Day in the Laboratory

- › **In Brief**
- › The Advantages
- › The Applications
- › The System
- › Technology and Details
- › Service

Axio Lab.A1 was developed for your daily work in the laboratory. The compact microscope operates continuously, reliably, and economically while providing the highest performance. You can use all conventional contrast methods: brightfield, darkfield, phase contrast, and fluorescence. Experience intuitive imaging with the free ZEN lite software. Or use Labscope, the imaging app from ZEISS. In combination with the AxioCam ERc 5s microscope camera, you can transform your Axio Lab.A1 into a Wi-Fi imaging system. The particular advantage of Axio Lab.A1 for those who spend long hours at the microscope is its TÜV-certified ergonomics. You can view your specimens from the most comfortable height. Your neck and shoulders stay relaxed even during long days in the laboratory.



Simpler. More Intelligent. More Integrated.

- › In Brief
- › **The Advantages**
- › The Applications
- › The System
- › Technology and Details
- › Service

TÜV-Certified Ergonomics for Relaxed Work in the Laboratory

It is possible to work long hours at the microscope without strain in your neck and shoulders: The viewing height of your Axio Lab.A1 is individually adjustable – you can alter the height and angle of view by adjusting the ergotube to suit your own body height. This allows you to always view your specimens from the most comfortable position, eliminating strain on your neck and shoulders. You can access all the main controls of your Axio Lab.A1 with one hand, including the stage drive, fine focus, and brightness control.

LED Illumination with Push & Click

Your Axio Lab.A1 is equipped with a fivefold Abbe turret condenser with darkfield and Ph1, Ph2, and Ph3. With the polarization contrast, you can capture birefringent structures such as crystals and fibers. For fluorescence applications, Axio Lab.A1 utilizes two LED positions and the proven Push & Click modules from ZEISS. LED fluorescence is more energy efficient and easier to handle than conventional HBO illumination. You avoid warm-up and cool-down times, lamp replacement, and lamp adjustment. In brightfield, you use the warm, white light effect of energy-efficient LEDs even while benefiting from their longer service life.

Versatile in Use, Brilliant Results

Axio Lab.A1 shines in laboratories for microbiology, cytology, hematology, and pathology. The microscope is ideally suited for work in parasitology and immunofluorescence and is a valuable working tool in schools and universities. With the multidiscussion equipment, up to three observers can view the same image. As the main observer, you highlight interesting regions in the sample using a light marker in white, red, or green. The excellent optics from ZEISS ensure brilliant, color-corrected, high-contrast results. The quality of the image leaves nothing to be desired.



Your Insight into the Technology Behind It

- › In Brief
- › **The Advantages**
- › The Applications
- › The System
- › Technology and Details
- › Service

TÜV-Certified Ergonomics – Perfectly Adapted

Laboratory microscopes such as Axio Lab.A1 are often used several hours a day for routine applications in hematology, pathology and cytology. The unique character of your Axio Lab.A1 stems from its excellent ergonomic qualities, stability, and sophisticated details. Axio Lab.A1 was developed and designed in collaboration with occupational health physicians and TÜV Rheinland to meet your most stringent ergonomic requirements for microscope workplaces. It is the first light microscope in the world to be available in a special ergonomic configuration that carries the “Ergonomics Approved” certificate (ID:0000025994) from TÜV Rheinland. Continuous adjustment of the viewing height of the ergotube through 50 mm lets you avoid neck and shoulder strain. The tube can also be pivoted continuously between 8 and 33 degrees.



Tailored Precisely to Your Applications

- › In Brief
- › The Advantages
- › **The Applications**
- › The System
- › Technology and Details
- › Service

Typical Applications, Typical Specimens	Task	ZEISS Axio Lab.A1 Offers
Genetic laboratory examinations	Examination of heparinized blood for cytogenetic (chromosome analysis) and molecular cytogenetic investigations (fluorescence in situ hybridization, FISH)	LED fluorescence with two LED positions and Push & Click modules: LED fluorescence is reliable, energy efficient, quick, and easy to use; additional advantages: no warm-up or cool-down times, no need for adjustment
Immunology	In vivo examination of the physiology of immune cells under normal and inflamed conditions in their natural environment	Fluorescent FITC markers for antigen/antibody reactions; FITC can be linked with antibodies (immunoglobulins); under LED excitation of 470 nm, FITC emits a green fluorescent signal, which allows detection of specific surface characteristics (antigens) in fluids, cells, or tissues, as well as pathogens
Hematology	Laboratory examination of blood samples (EDTA blood) for quantity, shape, and condition of blood cells	Axio Lab.A1 makes it easier to count erythrocytes and leukocytes; you can access all the main controls with one hand, including the stage drive, fine focus, and brightness control, leaving your other hand free for operating the leukocyte-counting device
Pathology	Examination of specimens such as cell smears, bone marrow, and blood samples as to structure, composition, and growth of the cells during laboratory work; efficiency and sample throughput are of major importance	TÜV-certified ergonomics specially aimed at long-term users – you observe your specimens from the most comfortable height your neck and shoulder muscles stay relaxed

ZEISS Axio Lab.A1 at Work

- › In Brief
- › The Advantages
- › **The Applications**
- › The System
- › Technology and Details
- › Service

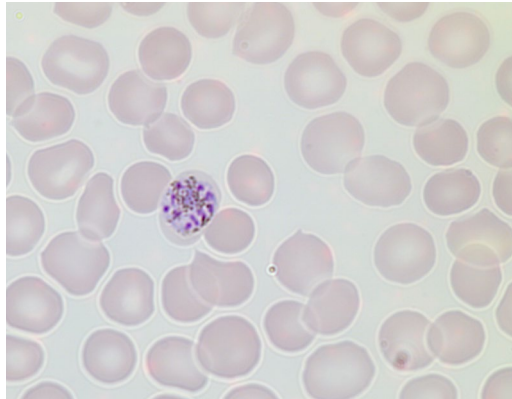

Hematology: *Plasmodium malariae*, daisy stage, brightfield; courtesy of A. Michelsen, Ortenau Klinikum in Lahr-Ettenheim, Germany

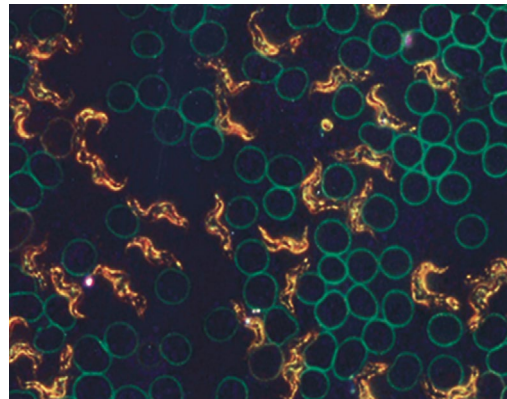

Hematology: blood smear, darkfield

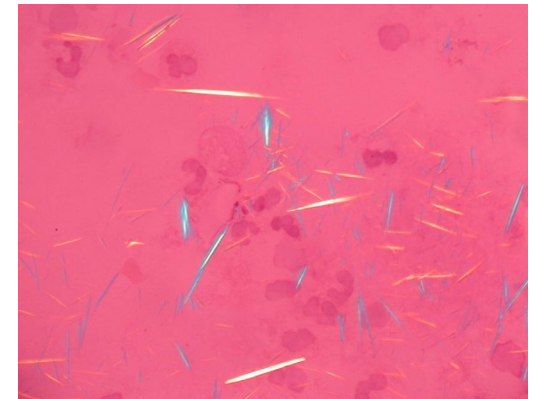

Gout examination: uric acid crystal, polarization

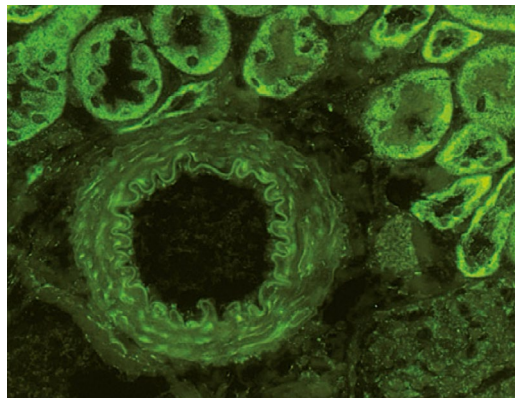

Mouse kidney, stained with FITC

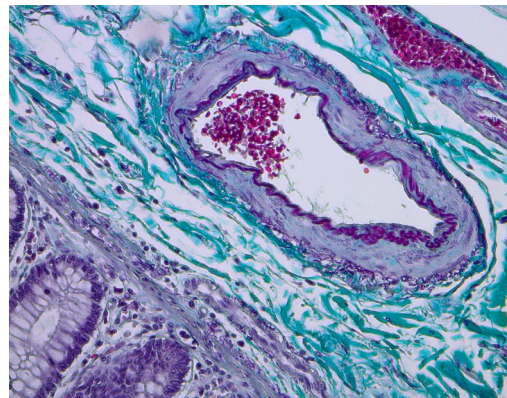

Pig gut, staining MG; objective: A-Plan 10x/0.25



Urine analysis: calcium carbonate, brightfield; courtesy of G. Spengler-Schulz, Alexander Fleming Schule in Stuttgart, Germany

Expand Your Possibilities

- › In Brief
- › The Advantages
- › **The Applications**
- › The System
- › Technology and Details
- › Service

ZEN lite for Your Imaging Tasks

Download ZEN lite, your free version of the ZEN Imaging Software. View your .czi files and take advantage of the many possibilities. With ZEN lite, you control your AxioCam microscope cameras, capture images and simple video sequences, measure lengths and areas interactively, and generate simple reports. Expand ZEN lite with selected modules and capture time-lapse images of your specimens or create multichannel fluorescent images.

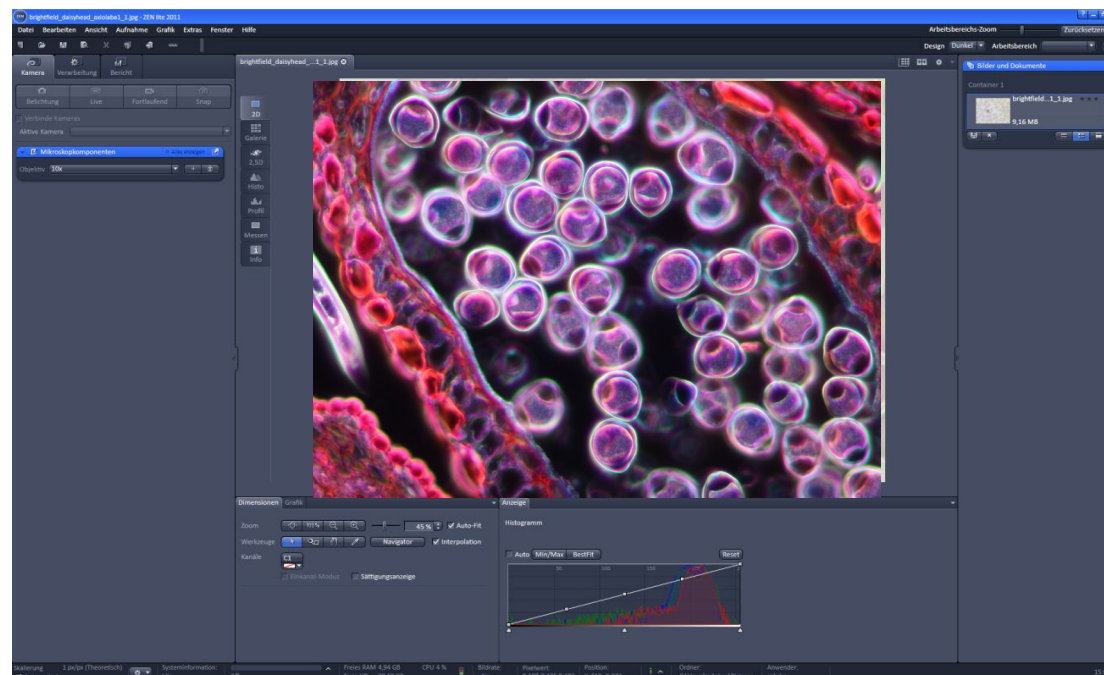

Expand Your Possibilities

- › In Brief
- › The Advantages
- › **The Applications**
- › The System
- › Technology and Details
- › Service

ZEISS Labscope – Your Doorway to the Digital World

With the imaging app Labscope from ZEISS, you can display all the live images from your connected microscopes. With just one click, select the image from one of your students. You can record images and videos in high five-megapixel resolution. Annotate your images and measure distances, for example. Then share your images, reports, and videos with others via e-mail, social media, or cloud services. With Labscope, you save your images in the ZEN-compatible .czi file format including all meta-data and a separate annotation layer. Or select the space-saving .jpg format. Download Labscope from the Apple App Store – easily, quickly, and free of charge.



Expand Your Possibilities

- › In Brief
- › The Advantages
- › **The Applications**
- › The System
- › Technology and Details
- › Service

Multidiscussion equipment

Using the multidiscussion equipment from ZEISS, you create identical image-viewing positions for all co-observers. Up to two co-observers see the same image in the same orientation as the main observer – this prevents confusion through image rotation or mirroring. The main observer and co-observer benefit from homogenous lighting in the field of view.

The movable light marker allows you to mark interesting structures or notable histological alterations in the prepared specimen. You provide an optimum orientation guide for differently stained specimens by continuously regulating the intensity of the light marker and selecting between the various color settings (white, green, red).

You can use the multidiscussion system for training and consulting situations and in the medical field, for example when teaching students and doctoral candidates, when performing consultations, or when jointly evaluating difficult specimens. By receiving a direct impression of the microscopic image, you are often better able to detect fine structures and nuances of color, particularly in the case of histologically stained transmitted-light specimens, such as tissue sections or blood smears, in the microscopic image.



Your Flexible Choice of Components

- › In Brief
- › The Advantages
- › The Applications
- › **The System**
- › Technology and Details
- › Service



1 Microscope

Axio Lab.A1:

- Stand with transmitted light
- Stand with transmitted light polarization
- Stand with transmitted light and reflected light fluorescence

2 Objectives

Recommended classes of objectives:

- A-Plan
- N-Achroplan
- EC Plan-NEOFLUAR

3 Illumination

Transmitted light:

- HAL 35 (halogen, integrated)
- LED illumination (warm white)

Reflected light:

- LED illumination (fluorescence)

4 Cameras

Recommended cameras:

- AxioCam MRc
- AxioCam ICc 5
- AxioCam ICc 1
- AxioCam ERc 5s

5 Software

- ZEN lite
- Labscope imaging app
- Labscope

6 Tubes

- Standard tubes
- Tubes with adjustable angle
- Tubes with adjustable height
- Tubes with adjustable angle and height

System Overview

- › In Brief
- › The Advantages
- › The Applications
- › **The System**
- › Technology and Details
- › Service

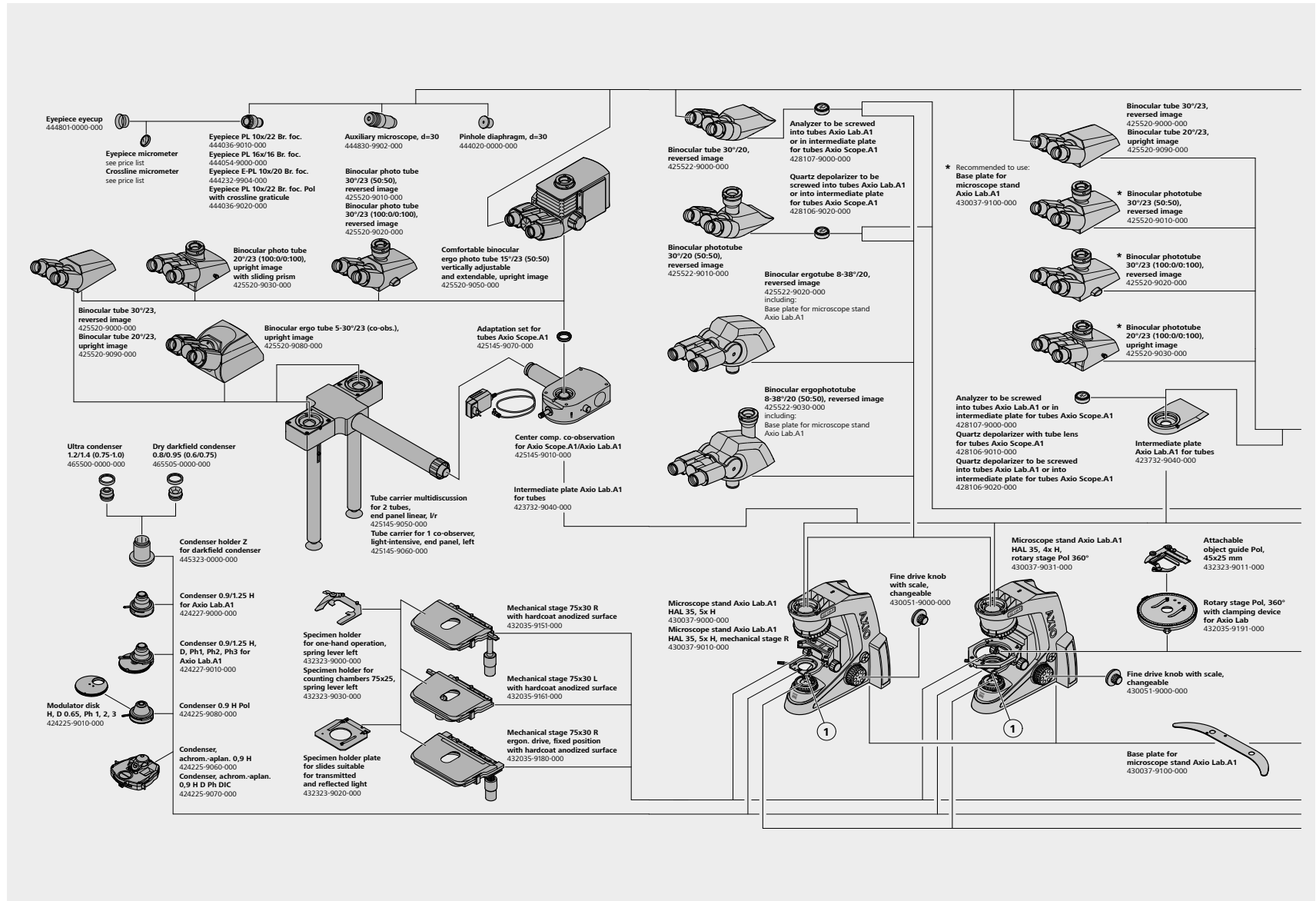

System Overview

- › In Brief
- › The Advantages
- › The Applications
- › **The System**
- › Technology and Details
- › Service

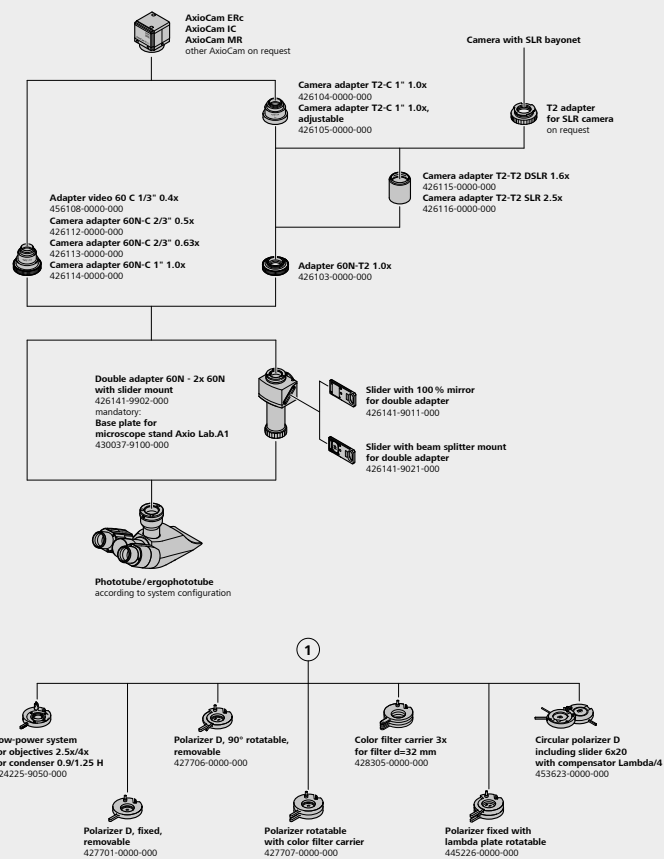

System Overview

- › In Brief
- › The Advantages
- › The Applications
- › **The System**
- › Technology and Details
- › Service

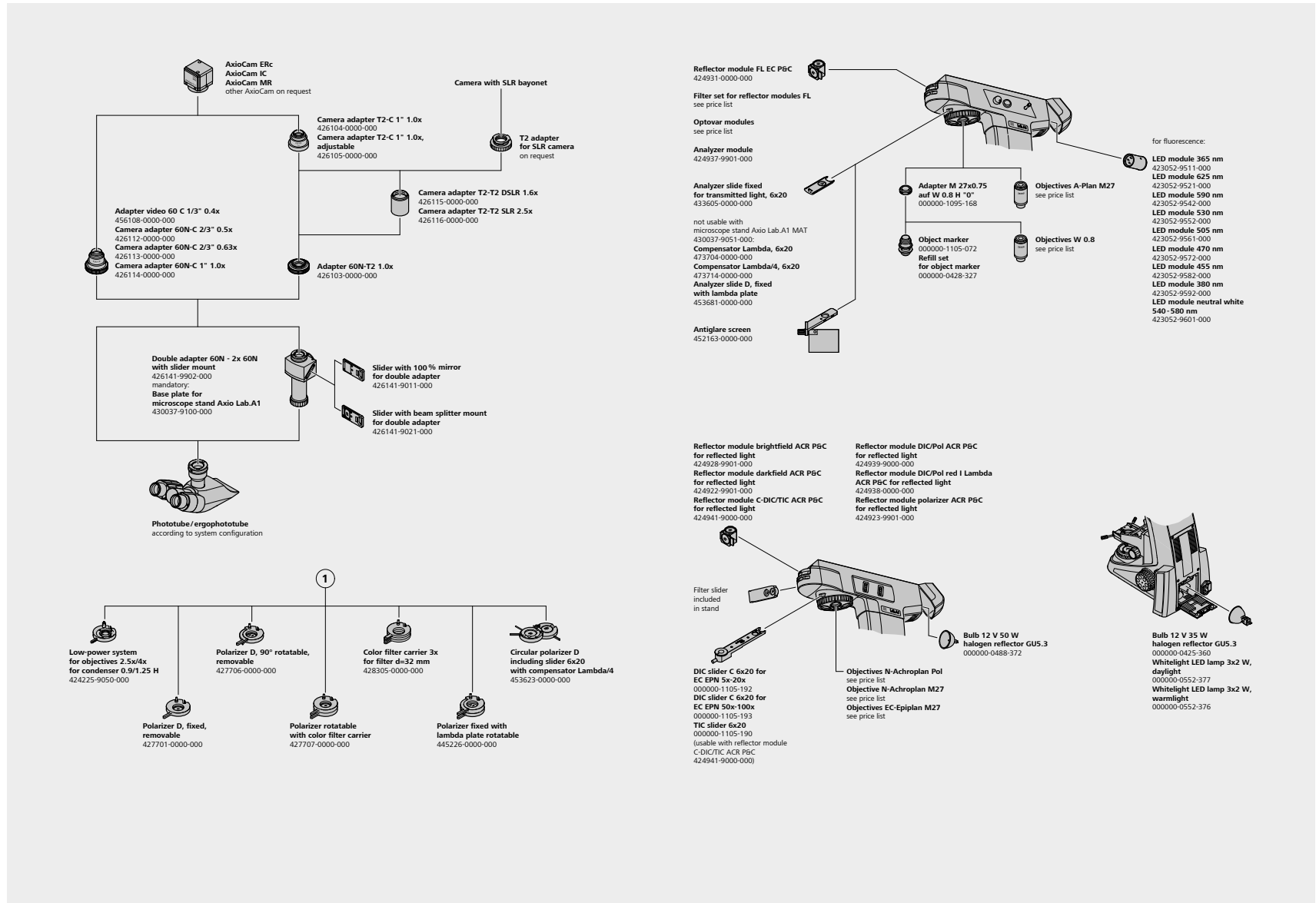

Technical Specifications

- › In Brief
- › The Advantages
- › The Applications
- › The System
- › **Technology and Details**
- › Service

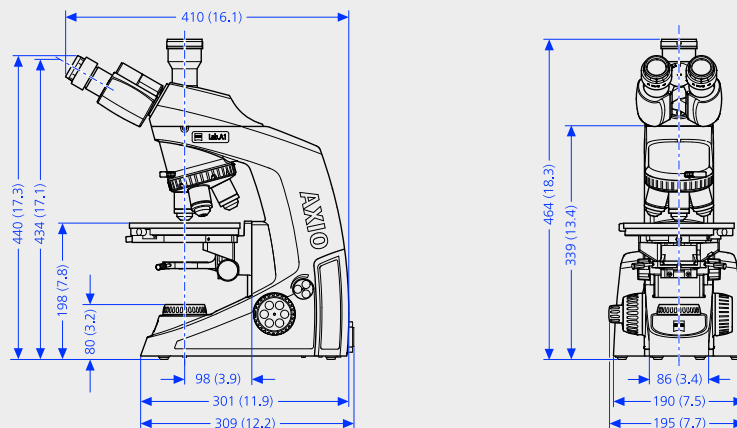

Dimensions (width × depth × height)

Axio Lab.A1 basic microscope stand
without tube (430037-9000-000)

Approx. 219 mm × 410 mm × 3395 mm

The other types of stands vary slightly in terms of depth and significantly in terms of height, depending on which tube is used; you can find an overview of the viewing heights of the various tubes in the user instructions

You can estimate the height of the stand with each type of tube

by adding 10 mm to the viewing height given in the lower Binteil position for tubes with a fixed viewing angle

by adding 10 mm to the viewing height given at the upper limit for ergotubes

Weight

Axio Lab.A1 microscope stand
(depending on variation and configuration)

Approx. 8 to 20 kg

Ambient transport conditions (in packaging):

Permissible ambient temperature

+10 °C to +40 °C

Storage

Permissible ambient temperature

+10 °C to +40 °C

Permissible humidity (without condensation)

Max. 75 % at 35 °C

Technical Specifications

- › In Brief
- › The Advantages
- › The Applications
- › The System
- › **Technology and Details**
- › Service

Operation

Permissible ambient temperature	+10 °C to +40 °C
Permissible relative humidity (without condensation)	Max. 75 % at 35 °C
Max. altitude	2,000 m
Atmospheric pressure	800 hPa to 1,060 hPa
Degree of pollution	2

Technical specifications

Area of use	Closed spaces
Protection class	I
Protection type	IP 20
Electrical safety in accordance with CSA and UL standards	In accordance with DIN EN 61010-1 (IEC 61010-1)
Overvoltage category	II
Radio interference suppression	In accordance with EN 55011, class B
Noise immunity	In accordance with DIN EN 61326
Mains voltage for Axio Lab.A1	100 to 240 V ±10%
	Mains voltage conversion is not necessary
Power frequency	50/60 Hz
Power consumption for Axio Lab.A1	110 VA

Fuses in accordance with IEC 127

Axio Lab.A1 microscope stand	2× T 3.15 A/H, 5 mm × 20 mm
------------------------------	-----------------------------

Technical Specifications

- › In Brief
- › The Advantages
- › The Applications
- › The System
- › **Technology and Details**
- › Service

Light sources

LED transmitted light illumination	Power consumption	Max. 3 W
	Light source adjustment range	Continuously variable, approx. 0.5 to 12 V
Transmitted halogen light	Power consumption	Max. 35 W
Reflected halogen light	Power consumption	50 W
	Light source adjustment range	Continuously variable, approx. 0.5 to 12 V
LED reflected fluorescent illumination with exchangeable LED modules	Choose between wavelengths	365 nm, 380 nm, 455 nm, 470 nm, 505 nm, 530 nm, 590 nm, 625 nm or neutral white (540 nm–580 nm)
LED classification	LED risk group 2 in accordance with IEC 62471	

Axio Lab.A1

Stand with manual stage focus	Coarse focus	Approx. 4 mm/rotation
	Fine focus	Approx. 0.4 mm/rotation; approx. 4 µm scale spacing
	Stroke range	30 mm
	Height stop	Preset at factory
	Choice between condenser 0.9/1.25 H with or without modulator disc for brightfield, darkfield, and phase contrast Ph1, Ph2, Ph3	
Manual change of objective	Using nosepiece turret, 4x H Pol or 5x H D, M27	
Manual change of reflector module	Using reflector turret, fourfold	

Count on Service in the True Sense of the Word

- › In Brief
- › The Advantages
- › The Applications
- › The System
- › Technology and Details
- › **Service**

Because the ZEISS microscope system is one of your most important tools, we make sure it is always ready to perform. What's more, we'll see to it that you are employing all the options that get the best from your microscope. You can choose from a range of service products, each delivered by highly qualified ZEISS specialists who will support you long beyond the purchase of your system. Our aim is to enable you to experience those special moments that inspire your work.

Repair. Maintain. Optimize.

Attain maximum uptime with your microscope. A ZEISS Protect Service Agreement lets you budget for operating costs, all the while reducing costly downtime and achieving the best results through the improved performance of your system. Choose from service agreements designed to give you a range of options and control levels. We'll work with you to select the service program that addresses your system needs and usage requirements, in line with your organization's standard practices.

Our service on-demand also brings you distinct advantages. ZEISS service staff will analyze issues at hand and resolve them – whether using remote maintenance software or working on site.

Enhance Your Microscope System.

Your ZEISS microscope system is designed for a variety of updates: open interfaces allow you to maintain a high technological level at all times. As a result you'll work more efficiently now, while extending the productive lifetime of your microscope as new update possibilities come on stream.



Profit from the optimized performance of your microscope system with a Carl Zeiss service contract – now and for years to come.

>> www.zeiss.com/microservice



Carl Zeiss Microscopy GmbH
07745 Jena, Germany
microscopy@zeiss.com
www.zeiss.de/axiolab

